

This is a general specification leaflet; for specific applications not covered herein, contact Suntec.

The SUNTEC AT2 oil pump features 2 mode pressure operation and incorporates a blocking solenoid valve with in-line cut-off function. Switching between low and high modes is assured by a 2nd integral solenoid valve.

APPLICATIONS

- Light oil, B10 heating oil/biofuel blend (as defined in DIN V51603-6) and kerosene.
- Two firing rates (with a sole nozzle line).
- One or two-pipe system.

PUMP OPERATING PRINCIPLE

The gear set draws oil from the tank through the built-in filter and transfers it to the nozzle line via the cut-off solenoid valve. Pressure regulation is assured by two spool valves, one for each pressure mode.

Switching between low and high pressure is assured by a "normally open" by-pass solenoid valve. When this solenoid is non-activated, a by-pass channel is open, allowing the normal functioning of the low pressure regulating valve which sets the nozzle pressure. When this solenoid is activated, the by-pass channel is closed, thus pressure will build up on both sides of the low pressure regulating valve eliminating its effect, and the high pressure regulating valve now determines the nozzle pressure.

The blocking solenoid valve of the nozzle line is of the "normally closed" type. This design ensures extremely fast response and the switching can be selected according to the burner operating sequence and is independent of motor speed.

When this solenoid valve is non-activated, the valve is closed and all oil pressurized by the gear set passes through the regulators to suction or to the return line, depending upon pipe arrangement.

As soon as this solenoid is activated, oil passes to the nozzle line at the pressure set by the pressure regulating valves.

In two pipe operation, the by-pass plug must be fitted in the return port, which ensures that the oil dumped by the regulating valves is returned to the tank and the suction line flow is equal to the gear set capacity.

Bleeding in two pipe operation is automatic (it is assured by a bleed flat on the piston of the low pressure regulator), but it may be accelerated by opening a pressure port.

In one pipe operation, the by-pass plug must be removed, and the return plugged. Oil which is not required at the nozzle is returned directly to the gear inlet via the pressure regulating valves, and the suction line flow is equal to the nozzle flow.

A pressure port must be opened to bleed the system.

PUMP IDENTIFICATION

(Not all model combinations are available
Consult your Suntec representative)

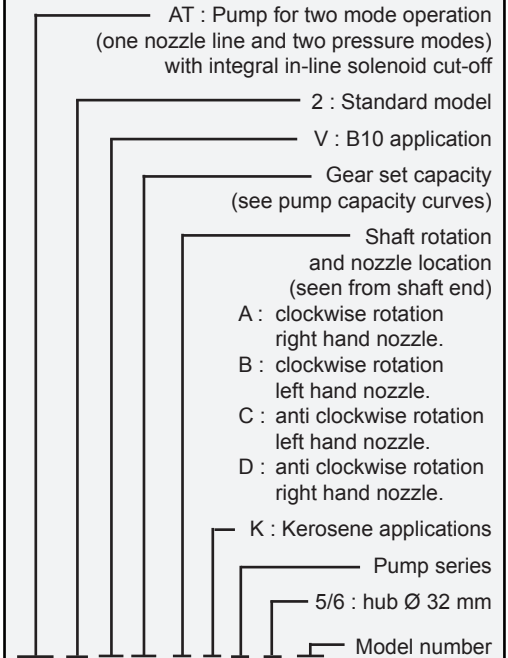

AT 2 V 45 C K 9 5 xx 4 P 07 00
Revision number
Installation P : by-pass plug installed in return port for two-pipe operation
Solenoid coil voltage 06 : 110 - 120 V ; 50/60 Hz 02 : 24 V ; 50/60 Hz 05/07 : 220 - 240 V ; 50/60 Hz
Connector cable length 00 : no cable 35 : 35 cm - 45 : 45 cm 60 : 60 cm - 10 : 1 m

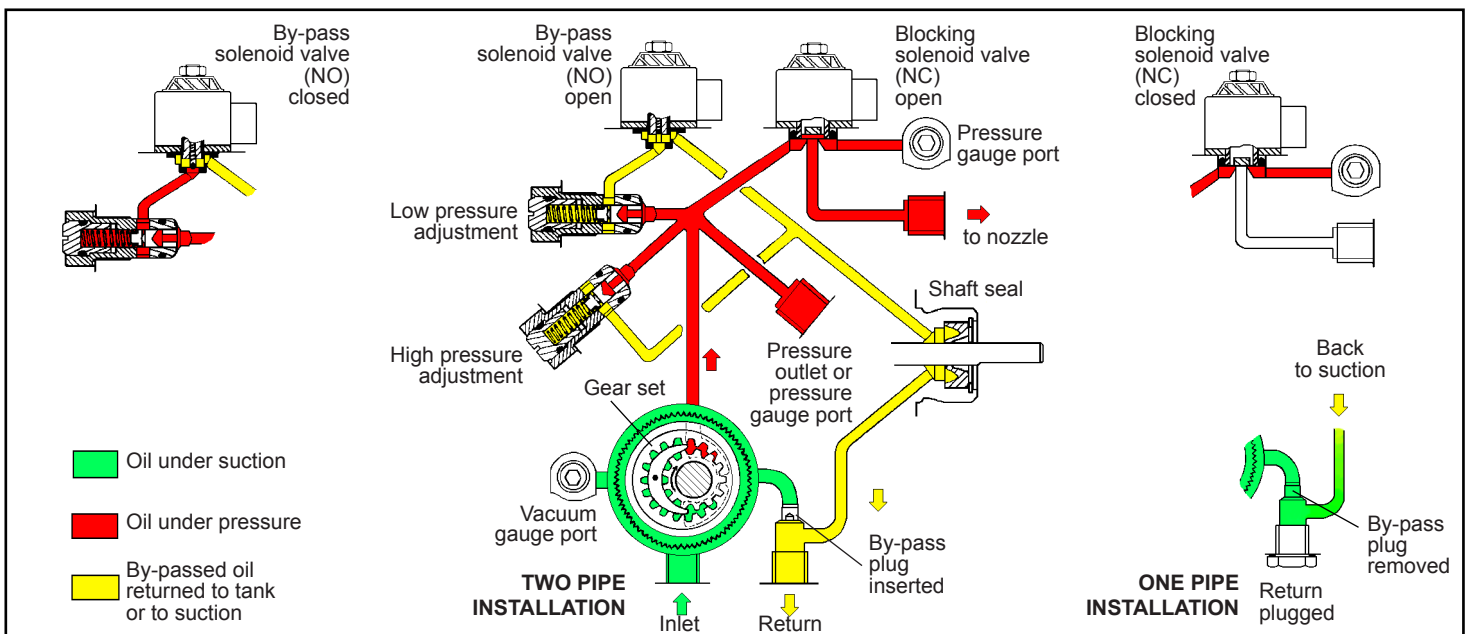

TECHNICAL DATA

General

Mounting	Hub mounting according to EN 225.
Connection threads	cylindrical according to ISO 228/1
Inlet and return	G 1/4 (with facilities for conical sealing on revision 6 models)
Nozzle outlet	G 1/8
Pressure gauge port	G 1/8
Vacuum gauge port	G 1/8
Valve function	Pressure regulation.
Strainer	open area : 6 cm ² (AT2 20,45/45K, 55/55K, 65/65K) 20 cm ² (AT2 75/75K, 95/95K) opening size : 150 µm
Shaft	Ø 8 mm according to EN 225.
By-pass plug	inserted in return port for two-pipe system ; to be removed from return port with a 4 mm Allen key for one pipe system.
Weight	1,3 kg.

Hydraulic Data

Gear size	45K/55K/65K/75K/95K	20/45/55/65/75/95
Nozzle pressure range*	@ 1,8 cSt	@ 5 cSt
Low mode :	8 - 15 bars	8 - 15 bars
High mode :	12 - 15 bars	12 - 25 bars

Delivery pressure settings*
Low mode : 9 bars
High mode : 22 bars

* AT2 75/95 : pressure obtained with a 12 GPH nozzle. Other ranges available on request, refer to the specified range of the particular fuel unit.

Operating viscosity	1,25 - 12 mm ² /s (cSt) for AT2 45K/55K/65K/75K/95K 2 - 12 mm ² /s (cSt) for AT2 20/45/55/65/75/95
Oil temperature	0 - 60°C in the pump
Inlet pressure	2 bars max.
Return pressure	2 bars max.
Suction height	0,45 bars max. vacuum to prevent air separation from oil.
Rated speed	3600 rpm max.
Torque (@ 45 rpm)	0,09 N.m (AT2 20) 0,10 N.m (AT2 45/45K, 55/55K) 0,12 N.m (AT2 65/65K) 0,14 N.m (AT2 75/75K) - 0,20 N.m (AT2 95/95K)

Solenoid valve characteristics

Voltage	220-240 or 110-120 or 24 V; 50/60 Hz
Consumption	9 W max.
Coil Code*	Ambient temperature
06/02/05	0 - 60 °C
07	0 - 80 °C
* Refer to "Pump identification - solenoid coil voltage".	
Maximum pressure	25 bars
Certified	TÜV Nr stamped on pump body.
Protection class	IP 54 according to EN 60529, when used with SUNTEC connector cable.

Pump capacity

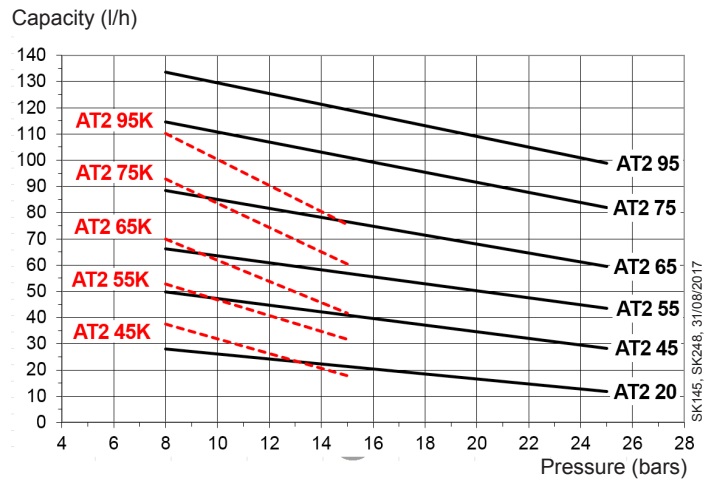

Data shown take into account a wear margin. Do not oversize the pump when selecting the gear capacity to ensure the optimum operation of the (NO) solenoid valve (switching low/high mode).

Power consumption

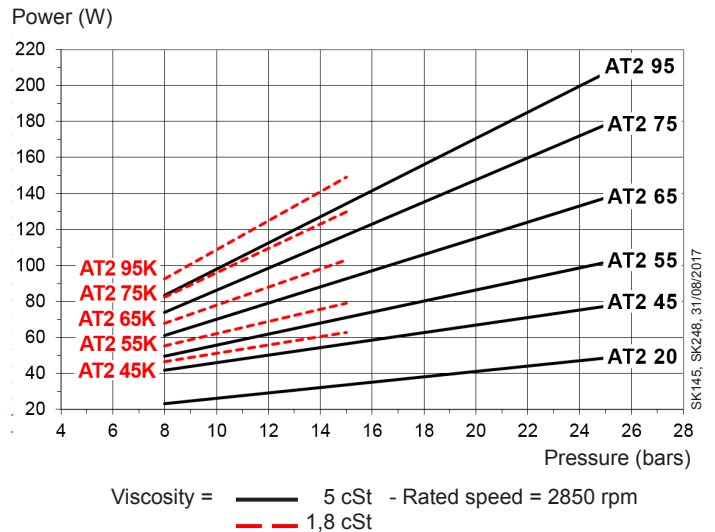

DIMENSIONS

Pumps revision 4/6 Example shows "C" rotation and nozzle outlet.

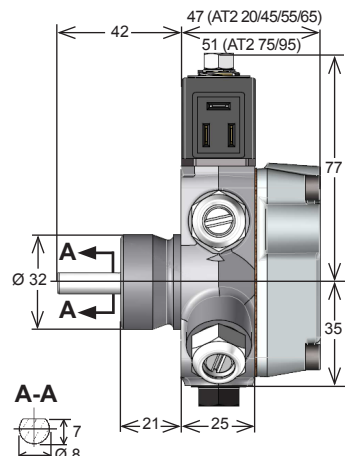
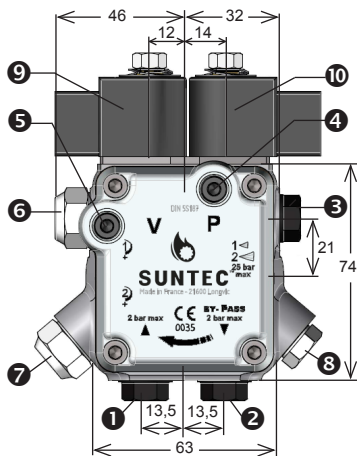

Inlet ① and Return ② with direct sealing for revision 6 models (sealing with washers can also be used)

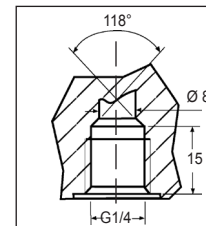

- ① Suction
- ② Return and internal by-pass plug
- ③ Nozzle outlet
- ④ Pressure gauge port
- ⑤ Vacuum gauge port
- ⑥ Low pressure adjustment
- ⑦ High pressure adjustment
- ⑧ Pressure outlet or pressure gauge port (only for rev 4 models)
- ⑨ Solenoid valve for switching low/high modes
- ⑩ Blocking solenoid valve